



INSTRUCTIONS D'ASSEMBLAGE
ASSEMBLY INSTRUCTIONS

MONARCH
SPECIALTIES INC.

I 3401

TABLES GIGOGNES -
ENS. 2PCS / BLANC LUSTRE / CHROME

NESTING TABLE -
2PCS SET / GLOSSY WHITE / CHROME METAL



POUR DE L'ASSISTANCE OU POUR COMMANDER
DES PIÈCES CONTACTEZ NOTRE DÉPARTEMENT
DE SERVICE À LA CLIENTÈLE.

FOR ASSISTANCE OR TO ORDER PARTS
CONTACT OUR CUSTOMER SERVICE DEPARTMENT

WWW.MONARCHSERVICE.COM

LISTE DES PIÈCES
PARTS LIST

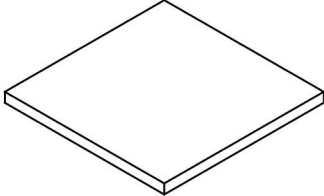
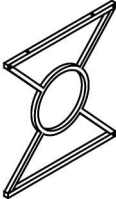
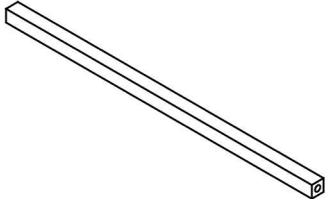
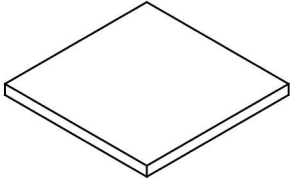
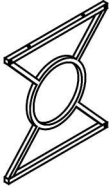
PIÈCE / PART #	IMAGE	DESCRIPTION	QTY / QTÉ
1		TABLE TOP (LARGE) DESSUS DE TABLE (GRAND)	1
2		LEG FOR LARGE TABLE PATTE POUR GRANDE TABLE	2
3		CROSSBAR (LONG) BARRE TRANSVERSALE (LONGUE)	3
4		TABLE TOP (SMALL) DESSUS DE TABLE (PETIT)	1
5		LEG FOR SMALL TABLE PATTE POUR PETITE TABLE	2

LISTE DES PIÈCES
PARTS LIST

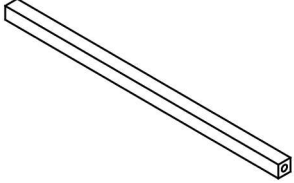
PIÈCE / PART #	IMAGE	DESCRIPTION	QTY / QTÉ
6		CROSSBAR (SHORT) BARRE TRANSVERSALE (COURTE)	3

LISTE DES PIÈCES DE MONTAGE
HARDWARE LIST

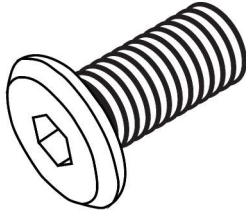
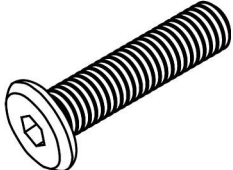
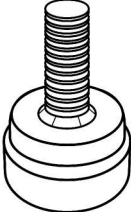
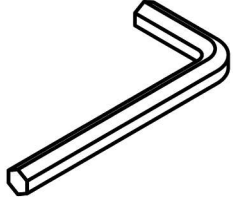
PIÈCE / PART #	IMAGE	DESCRIPTION	QTY / QTÉ
A		ASSEMBLING BOLT - Ø1/4" X 1 1/8" BOULON D'ASSEMBLAGE - Ø1/4" X 1 1/8"	8
B		ASSEMBLING BOLT - Ø1/4" X 1 1/2" BOULON D'ASSEMBLAGE - Ø1/4" X 1 1/2"	12
C		ADJUSTABLE LEG - Ø1/4" X 1/2" PATTE AJUSTABLE - Ø1/4" X 1/2"	8
D		HEX KEY CLÉ HEXAGONALE	1

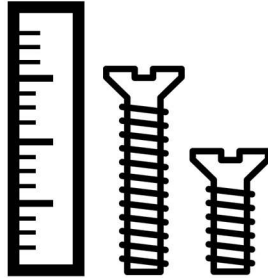

OUTIL DE VÉRIFICATION DE DIMENSIONS DES PIÈCES
HARDWARE DIMENSIONS VERIFICATION TOOL

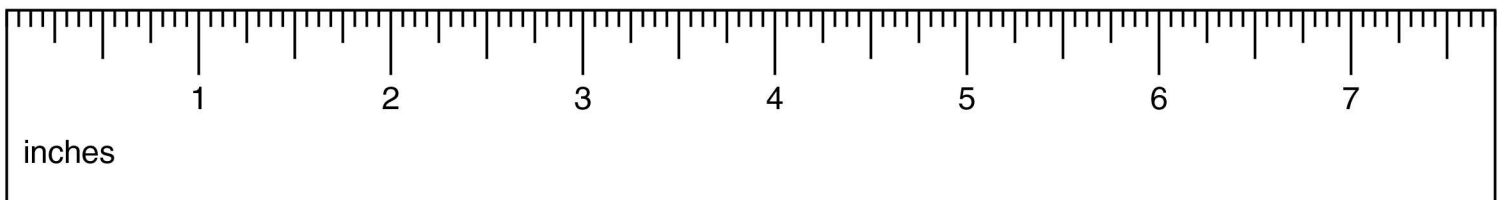

ÉTAPE / STEP 1

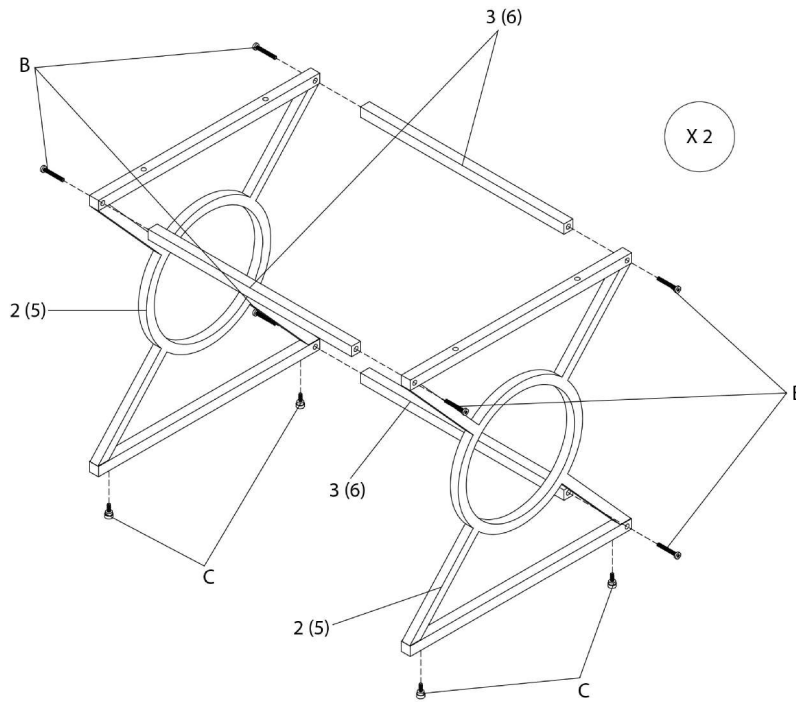

ÉTAPE / STEP 2

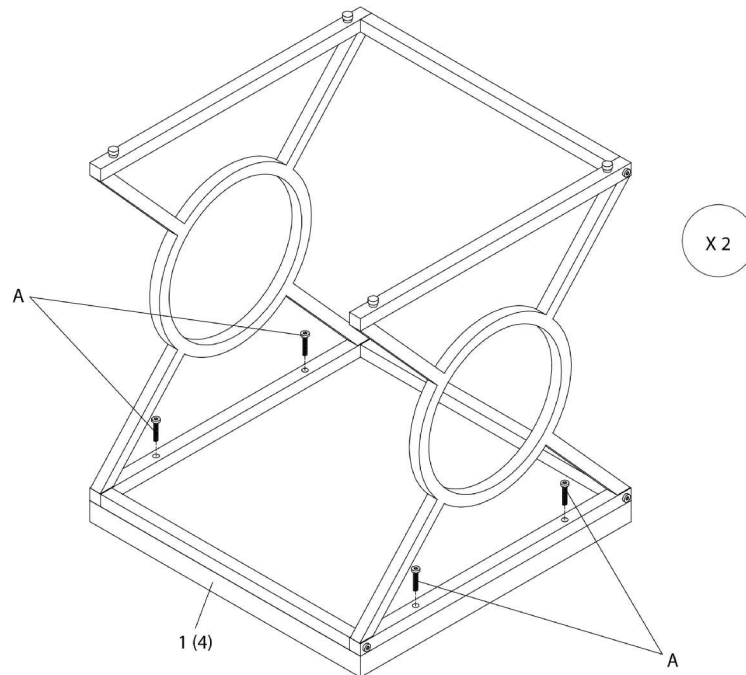

ÉTAPE / STEP 3

